



elementa

General Pricelist 2022 - Version 1.0
Norwegian Kroner







In this pricelist you can find the complete Elementa collection of essentialist furniture and hardware for home and workspace - and a few items crossing over into new frontiers.

The products, surfaces, edges and sizes in the list form our standard collection. For projects, we can offer more options. Please refer to the appendix for an overview over preferred materials for specials.

Regular delivery time for standard items is 4-8 weeks if not otherwise specified.

When ordering, please specify model name, size, surface type, colour and edging where applicable.

All prices are recommended sales prices - given in NOK excl VAT, delivered to our warehouse in Oslo.

(For the Klorofyll Planter System range please see the separate dedicated pricelist)



Index

Ur Watercans	5
Cascade	7
Vava	9
Tot Seat	11
Koloni	13
Undivided Furniture System	15
ON Low Tables	18
O3 Floating Cabinets	21
dB Silent Cabinets	25
X1 Seamless Table System	28
U1 Plane Table	37
A1 Angled Table	43
HI Table	48
W1 Wired Table	50
E1 Height Adjustable Table	54
E3 Height Adjustable Table	58
MU Acoustic Panels - Wall Hanging	62
UM Acoustic Screens	69
NO Desk Screens	76
O2 Straight Storage	81
Derive	87
Standard Materials & Surfaces	89
Fabrics for Screens	90
Special Materials	92
Terms & Conditions	96



Ur Watercans

Design: Kneip







Sharing water with plants is a ritual worth doing gracefully and mindfully. Designed by the Norwegian art and design studio Kneip, the Ur water cans are carefully hand made in stainless steel and covered with enamel to give an elegant glossy finish that will just grow more beautiful as you use it.



Ur Watercans

Design: Kneip

		Dimension	
Ur 1 White enamel		Ø100mm x H150mm	2 723
Ur 2 White enamel		Ø105mm x H270mm	3 218
Ur 1 Black enamel		Ø100mm x H150mm	2 723
Ur 2 Black enamel		Ø105mm x H270mm	3 218

Please inquire about availability



Cascade

Design: Edvin Klasson



A lightweight and minimalist coat stand comprised of only two parts. Clothes hangers can be hung underneath the tallest loop, and the way each hook is angled makes for generous spacing between each garment.



Cascade

Design: Edvin Klasson

**Cascade
coat hanger**



Dimension

Ø50 cm / H179 cm

**Grey, black
or orange**

4 048



Vava

Design: Kristine Five Melvær



A stackable stool that combines classical elements in a new way. The name is inspired by the legs which moves up and down around the stool in a steady rhythm, giving the furniture its recognizable character.



Vava

Design: Kristine Five Melvær

Dimension

Vava wood- black
stained ash.



5 535

Vava wood - natural
ash.



5 535

Vava metal - steel
tube legs with a seat
in solid ash.



4 520

Expected ready for delivery from October 2022

Please inquire about availability and colour options for project orders.



Tot Seat

Design: Edvin Klasson



Named after the Egyptian god for writing, Tot is a fantastical upholstered seat that suggests the medicinized look and feel of conventional work furniture is a passed stadium. Its three legs provide great stability and freedom of movement, giving excellent support to any seated activity.



Tot Seat

Design: Edvin Klasson

Dimension

Upholstred in GU Prinsdal fabric

Tot Seat. Upholstered with Prinsdal fabric.



H 455 x 650 x 550 mm

9 268

Please inquire for other fabrics. Some stretch is required.



Koloni Insect Hotel

Design: Edvin Klasson



A micro-architectural structure made to shelter pollinating bees. The hotel consists of a rugged aluminium exterior protecting an inner core of solid wood with various sized rooms, ensuring warm and dry nesting facilities.



Koloni

Design: Edvin Klasson

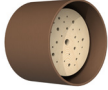
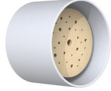
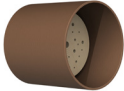
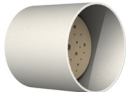
		Dimension	
Koloni Lacquered		Ø20 cm D15 cm	1 595
Koloni Natural Alu		Ø20 cm D15 cm	1 595
Koloni Lacquered		Ø20 cm D20 cm	1 925
Koloni Natural Alu		Ø20 cm D20 cm	1 925



Undivided Furniture System

Design: StokkeAustad



Designed by StokkeAustad, the Undivided furniture system grew out of a quest for unbounded spatial flexibility. The core of the idea is the trestle base, opening a world of possibilities.

By combining the angulation and amount of trestles, you can accommodate almost any table size and shape. It also folds in, and stacks away very nicely.



Undivided Furniture System - Technical details

Tabletop and shelf

Tabletops and shelves are made in 25 mm chipboard. HPL version has ABS edges and sharp corners, while the wooden versions have veneer band edges and rounded with a radius of 70mm.

Standard finishes:

- White HPL with ABS edges (sharp corners)
- White pigmented oak veneer with oak banding edges (rounded corners)
- Black painted oak veneer with oak banding edges (rounded corners)



Base

Flexible trestle frame in powder lacquered metal with movable joint. Table tops and shelves can rest on top of the trestle, or be attached on a disk that can be screwed into the table top.

Standard base colours:

- Black lacquered
- White Lacquered



Specials

For projects metal parts can be lacquered in any colour. Tabletops are available in any melamine, HPL, linoleum, Valchromat or veneer from our specials program as presented in the appendix. Please inquire for pricing and minimum quantities.

Forbo Desktop Linoleum:



Melamine & HPL:



Veneers:











Valchromat:





Undivided Furniture System

Design: StokkeAustad

		Dimension	White HPL, White Pigmented Oak Black Painted Oak
UN Desk 1400 x 700		W 1400 x D 700 x H 740	8 276
UN Desk 1600 x 800		W 1600 x D 800 x H 740	9 396
UN Desk with shelf 1600 x 800 + 2000 x 350		W 1600 x D 2000 x H 740 - shelves: 2000 x 350	15 722
UN Freestanding Shelf 2000 x 350		W 2000 x D 420/350 x H 560/720	8 793
UN Meeting Table 2000 x 900		W 2000 x D 900 x H 740	13 186
UN Single Shelf 2000 x 350		W 2000 x D 350	2 946
UN Occasional Tabletop 640 x 840		W 640 x D 840	2 217
UN Trestle One piece		W 600 x D 600 x H 720	1 898



ON Low Tables

Design: StokkeAustad



ON is a series of lounge tables based on the simplest possible shape, the circle. The three-legged tubular base gives the tables a floating, minimal character and allows tables of different sizes and height to be placed above each other to produce an elegant landscape of roundness.



ON Low Tables - Technical details

Tabletop

Tabletops are made in 25 mm MDF board with painted oak veneer, with a visible wood structure. Oak edges are chamfered to 10 mm.

Choose between the following tabletop / base alternatives:

- White painted oak veneer / white base
- Red painted oak veneer / red base
- Black painted oak veneer / black base
- Oak veneer with oak edge. / black or white base



Base

Feet in lacquered tubular steel. Colour follows the tabletop finish, choose white or black for the natural oak version.



Specials

For projects sizes, materials and finishes may be customized to fit specific needs. Please inquire for pricing, minimum quantities and lead times. Please refer to our specials program as presented in the appendix.

Forbo Desktop Linoleum:



Melamine & HPL:



Veneers:



Valchromat:





Please refer to the appendix for further details and images of custom surfaces.



ON Low Tables

Design: StokkeAustad

		Dimension	Red, white or black painted oak veneer
ON 01 Ø700		Ø 700 x H 500	7 205
ON 02 Ø900		Ø 900 x H 400	8 374
ON 03 Ø1200		Ø 1200 x H 300	10 194



O3 Floating Cabinets

Design: StokkeAustad



Even in a masterfully organized, paperless office space, surfaces will mysteriously attract stuff. Designed by StokkeAustad, the O3 Floating Cabinets is a series of minimalist cabinets with a clear-cut visual profile and some beautiful details.

With its metal base partly hidden by the skirt of the carcass, the cabinet gives the impression of floating, as does the slightly elevated top.



03 Floating Cabinets - Technical details

Carcass

Carcass and doors are made in 18 mm MFC board with 1,5 mm ABS edges. Veneer versions are made in chipboard with 1,5 mm solid oak edges. Cutout for handles.

Choose between the following finishes:

- White
- Grey
- Anthracite
- White pigmented oak



Base

Base in either powder-lacquered steel or, at a given upcharge - in solid oak.

Choose between the following base alternatives:

- White metal base
- Grey metal base
- Anthracite metal base
- Solid oak - lacquered with white pigment. (upcharge)
- Solid oak - anthracite stained oak. (upcharge)



Specials

For projects sizes, materials and finishes may be customized to fit specific needs. Please inquire for pricing, minimum quantities and lead times.

Forbo Desktop Linoleum:



Melamine & HPL:



Veneers:



Valchromat:









Please refer to the appendix for further details and images of custom surfaces.



O3 Floating Cabinets







Design: StokkeAustad

		White / Grey / Anthracite melamine	Oak veneer
O3 tall Freestanding With doors W 800		W 800 x D 400 x H 1306 7 497	15 742
O3 normal Freestanding With doors W 1200		W 1200 x D 400 x H 906 8 744	18 362
O3 wide Freestanding With doors W 1800		W 1800 x D 450 x H 606 11 243	23 612
O3 tall Wallmounted With doors W 800		W 800 x D 400 x H 1306 7 497	15 742
O3 normal Wallmounted With doors W 1200		W 1200 x D 400 x H 906 8 744	18 362
O3 wide Wallmounted With doors W 1800		W 1800 x D 450 x H 606 11 243	23 612
Upcharge for solid oak legs			2 995

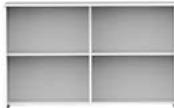

03 Floating Cabinets

Design: StokkeAustad

		White / Grey / Anthracite melamine	Oak veneer	
03 tall Freestanding Open shelf W 800		W 800 x D 400 x H 1306	6 247	13 119
03 normal Freestanding Open shelf W 1200		W 1200 x D 400 x H 906	7 912	16 616
03 wide Freestanding Open shelf W 1800		W 1800 x D 450 x H 606	10 713	22 498
03 tall Wallmounted Open shelf W 800		W 800 x D 400 x H 1306	6 247	13 119
03 normal Wallmounted Open shelf W 1200		W 1200 x D 400 x H 906	7 912	16 616
03 wide Wallmounted Open shelf W 1800		W 1800 x D 450 x H 606	10 713	22 498
Upcharge for solid oak legs				2 995



dB Silent Cabinets

Design: StokkeAustad



The dB storage series is the result of long hours of discussions with designers Jonas & Øystein at StokkeAustad - on the relationship between high quality work and our physical surroundings.

Pondering the implications of new trends, productivity and even the coming of hard AI - one thing really towered the discussion:

***** Silence *****



dB Silent Cabinets - Technical details

Carcass

The carcass is made in 18 mm MFC board with 1,5 mm ABS edges. Veneer versions are made in chipboard with 1,5 mm solid oak edges. The doors are made in aluminium with acoustic wool felt inlay kept in place by slats in solid oak.

Choose between the following carcass and door finishes:

- White carcass / white pigmented oak slats / beige acoustic felt.
- Anthracite / anthracite stained oak slats / anthracite acoustic felt.
- White pigmented oak carcass / white pigmented oak slats / beige or anthracite acoustic felt.



Base

Base in either powder-lacquered steel or, at a given upcharge - in solid oak.

Choose between the following base alternatives:

- White metal base (standard)
- Grey metal base (standard)
- Anthracite metal base (standard)
- Solid oak base - lacquered with white pigment. (+upcharge)
- Solid oak base - anthracite stained oak. (+upcharge)



Specials

For projects sizes, materials and finishes may be customized to fit specific needs. Please inquire for pricing, minimum quantities and lead times.

Forbo Desktop Linoleum:



Melamine & HPL:



Veneers:





Valchromat:



Please refer to the appendix for further details and images of custom surfaces.



dB Silent Cabinets

		White / Anthracite Melamine	Oak Veneer
dB tall Freestanding W 800		W 800 x D 400 x H 1306 13 932	22 290
dB normal Freestanding W 1200		W 1200 x D 400 x H 906 21 634	29 423
dB wide Freestanding W 1800		W 1800 x D 450 x H 606 25 960	41 536
Upcharge for solid oak leg			2 995
Free choice of RAL colour for metal frame			1 980



X1 Seamless Table



The X1 Seamless Table is a family of tables with a classical modernist expression, with technical features updated for today's needs. It may be one of the most versatile and comprehensive systems of its kind.

With several different versions available, the series expands seamlessly into all areas of the contemporary workspace - from desks to foldable conference tables and multi-leg boardroom tables.



X1 SeamlessTable - Technical details

Tabletop

Melamine versions are made in 25 mm MFC board. The HPL, linoleum and oak veneer versions are made in 25 mm MDF board.

Choose between the following tabletop alternatives:

- White melamine with straight, white ABS edge
- Grey melamine with straight, grey ABS edge
- Anthracite melamine with straight, anthracite ABS edge
- White HPL with chamfered, white lacquered MDF edge
- Black linoleum with chamfered, black lacquered MDF edge
- Oak veneer, white pigmented - with straight, 2 mm solid oak edge



Frame

The table base is made with feet in polished aluminum with a steel tube column lacquered black or white. At a given upcharge the whole base may be monocoloured black or white.

Choose between the following base options:

- Polished aluminium feet with black column
- Polished aluminium feet with white column
- All black lacquered base (upcharge)
- All white lacquered base (upcharge)



Specials

For projects sizes, materials and finishes may be customized to fit specific needs. Please inquire for pricing, minimum quantities and lead times.

Forbo Desktop Linoleum:



Melamine & HPL:



Veneers:



Valchromat:



Please refer to the appendix for further details and images of custom surfaces.



X1 Seamless Tables - Technical details

Cable management

Cable door in tabletop material (only available for MDF versions). As a default, the cable door is placed in the middle of the tabletop. Other solutions are possible on request.

Choose between the following cutout solutions:

- No Cutout
- Single cable door in table top material - 400x160 mm
- Double cable door in table top material - 400x200 mm



X1 Seamless Table - Central Columns

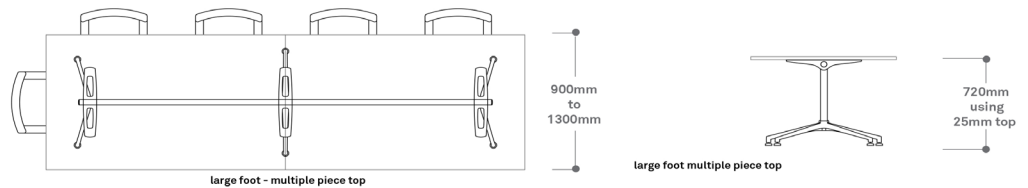
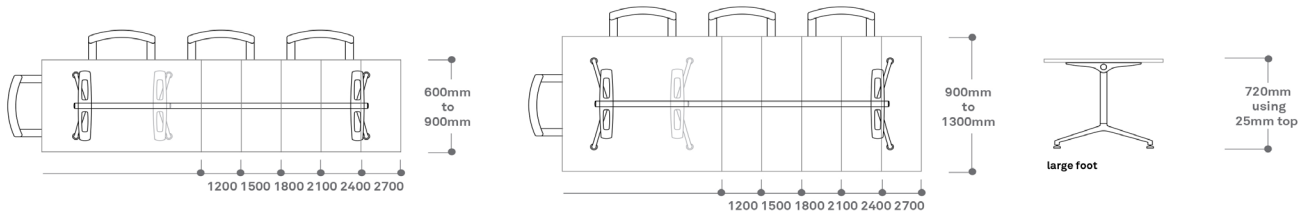



			White, Grey, Anthracite Melamine	White HPL Black linoleum Oak veneer	
X1 2 columns W 600		Dimension			
		W 1400 x D 800	9 396	13 654	
		W 1600 x D 800	9 772	15 255	
		W 1800 x D 900	10 350	18 305	
		W 2000 x D 900	10 601	22 476	
		W 2400 x D 900	11 088	24 077	
X1 2 columns W 800		W 1800 x D 1200	10 662	17 922	
		W 2000 x D 1200	11 637	23 896	
		W 2400 x D 1200	12 486	26 178	
		W 2600 x D 1200	15 478	27 458	
X1 3 columns W 800		W 3400 x D 1200	2 piece desktop	26 070	42 789
		W 4200 x D 1200	2 piece desktop	27 574	51 259

Please note that there is an upcharge for monocoloured frame - the standard frame is black with polished feet.



X1 Seamless Table - Central Columns

			White, Grey, Anthracite Melamine	White HPL Black linoleum Oak veneer
X1 4 columns W 800		Dimension		
		W 5400 x D 1200	3 piece desktop	33 398
		Upcharge for monocolored black- or white frames pr table		1 650
X1 Cable door		In finish as desktop material. Only available with HPL, linoleum and veneer		1 980
X1 Double cable door		In finish as desktop material. Only available with HPL, linoleum and veneer		2 750

Please note that there is an upcharge for monocoloured frame - the standard frame is black with polished feet.



X1 Seamless Table - Multi Columns

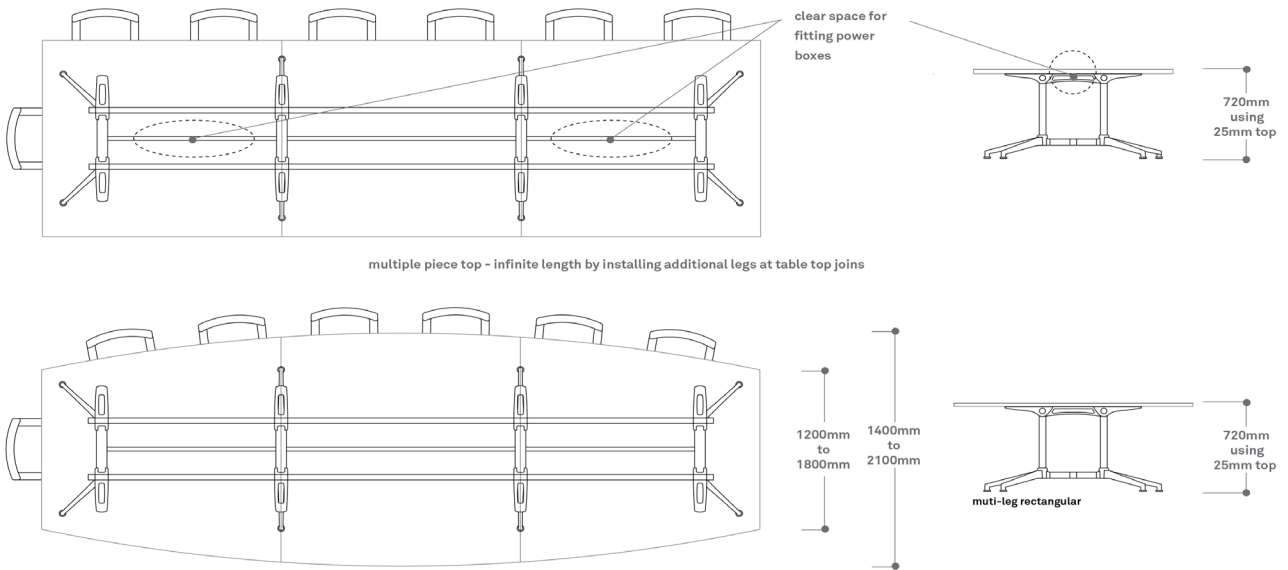

		White, Grey, Anthracite Melamine	White HPL Black linoleum Oak veneer
X1 4 columns W 1100		W 2200 x D 1400	32 802
X1 6 columns W 1100		W 3600 x D 1400 2 piece desktop	39 504
X1 6 columns W 1100		W 4800 x D 1400 2 piece desktop	44 597
X1 8 columns W 1100		W 6800 x D 1400 3 piece desktop	61 421
X1 Monocolour frame		Upcharge for monocolored black- or white frame pr table	2 750
X1 Cable door		In finish as desktop material. Only available with HPL, linoleum and veneer	1 980
X1 Double cable door		In finish as desktop material. Only available with HPL, linoleum and veneer	2 750



X1 Seamless Table - 4 Star and 5 Star Columns

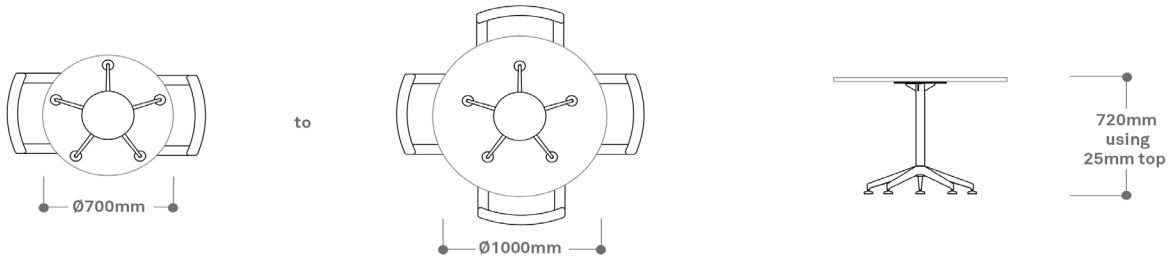

suits tables from 700mm Ø minimum to 1000mm Ø maximum

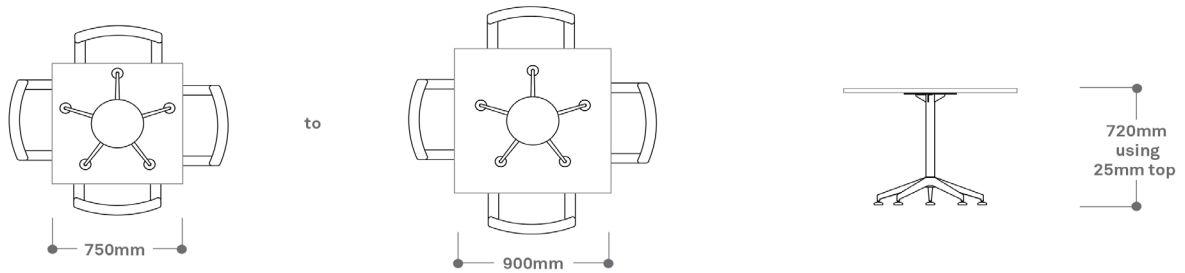

suits tables from 750mm square minimum to 900mm square maximum

	Dimension	White, Grey, Anthracite Melamine	White HPL Black linoleum Oak veneer
X1 5 star frame	W 700 x D 700	5 834	8 979
	Ø 700	6 613	8 339
X1 4 star frame	W 900 x D 900	8 792	13 292
	Ø 900	9 814	12 652
	Ø 1200	10 545	15 853
X1 Monocolour frame	Upcharge for monocolored black- or white frame pr table.		1 650
X1 Cable door	In finish as desktop material. Only available with HPL, linoleum and veneer		1 980



X1 Seamless Table - 4 Columns

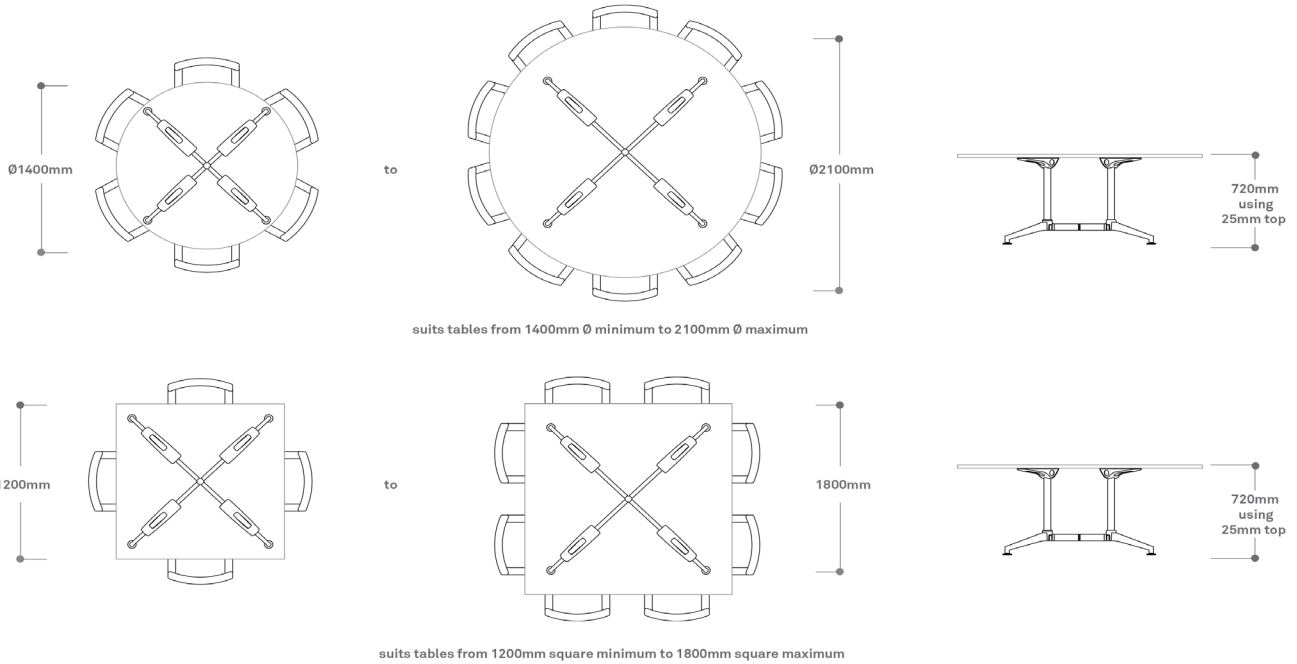

		White, Grey, Anthracite Melamine	White HPL Black linoleum Oak veneer
X1 4 columns W 1200		W 1200 x D 1200	17 853 26 028
X1 4 columns W 1500		W 1500 x D 1500 HPL version 1450 x 1450 mm	18 487 29 869
X1 4 columns W 1750		W 1750 x D 1750 HPL version not available	19 071 30 830
X1 4 columns Ø 1500		Ø 1500 HPL version measures Ø1450 mm	21 311 28 909
X1 4 columns Ø 1750		Ø 1750 HPL is not available	22 286 29 869
X1 Monocolour frame		Upcharge for monocolored black- or white frame pr table.	2 750

For cable door options, see previous pages.



X1 Seamless Folding Tables

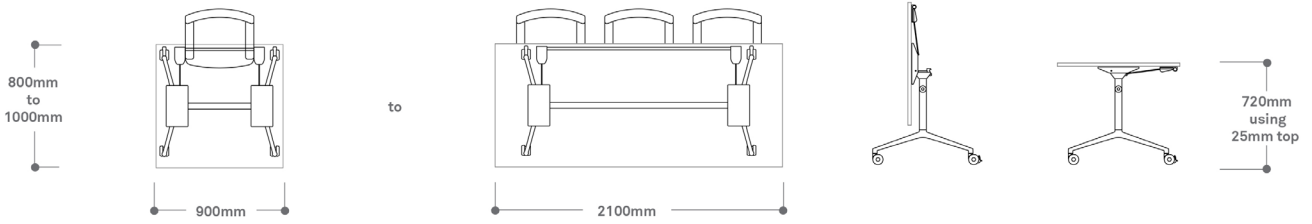

available in four beam lengths to suit tables from 900mm minimum to 2100mm maximum

		White, Grey, Anthracite Melamine	White HPL Black linoleum Oak veneer	
X1 Folding table W 1400		W 1400 x D 700	10 066	14 323
X1 Folding table W 1600		W 1600 x D 700	10 803	16 286
X1 Folding table W 1800		W 1800 x D 900	12 835	20 794
X1 Folding table W 2000		W 2000 x D 900	13 079	24 956
X1 Folding table 5 star frame		Ø 700	6 613	8 339
X1 Folding table 4 star frame		Ø 900	10 557	13 395
X1 Monocolour frame		Upcharge for monocolored black- or white frame pr table		1 650



U1 Plane Table



The U1 Plane Table is really an archetype of a modernist work table, conceptualized, designed and executed in the most rational way possible. With the tabletop appearing as if floating on the base, it marries uncompromised simplicity with a bit of sophistication.

The series incarnates neatly in many different formats - including single desks, shared workstations, meeting tables and more.



U1 Plane Table - Technical details

Tabletop

Melamine versions are made in 25 mm MFC board. The HPL, linoleum and oak veneer versions are made in 25 mm MDF board.

Choose between the following tabletop alternatives:

- White melamine with white ABS edge
- Grey melamine with grey ABS edge
- Anthracite melamine with anthracite ABS edge
- White HPL with white ABS edge
- Black linoleum with black lacquered MDF edge
- Oak veneer, white pigmented - with 2 mm solid oak edge



Base

The legs are made from metal tubes - 40x40 mm in powder coated metal. Metal to metal connections secure easy and quick assembly / disassembly. All legs have plastic feet with height levelling (+10 mm).

At a given upcharge single desk versions may be ordered in a manually height adjustable version. (H 620 - 850 mm)

Choose between the following base colours:

- White
- Grey
- Anthracite
- Black



Specials

For projects sizes, materials and finishes may be customized to fit specific needs. Please inquire for pricing, minimum quantities and lead times.

Forbo Desktop Linoleum:



Melamine & HPL:



Veneers:



Valchromat:



Please refer to the appendix for further details and images of custom surfaces.



U1 Plane Table - Technical details







Cable Cutouts

Choose between the following cutout alternatives:

- No cutout
- Bowshaped cutout in the back
- Cutout for metal cable, centered / back (desks only)
- Cutout for metal cable door in the absolute centre (meeting tables only)
- Sliding desktop (desks only)





U1 Plane Table

		Dimension	White / Grey / Anthracite melamine	White HPL Black linoleum Oak veneer
U1 Single desk D600		W 1200 x D 600 x H 740	3 220	6 761
		W 1400 x D 600 x H 740	3 438	7 219
U1 Single desk D700		W 1400 x D 700 x H 740	3 656	7 679
		W 1600 x D 700 x H 740	3 873	8 137
		W 1800 x D 700 x H 740	4 081	8 569
U1 Single desk D800		W 1400 x D 800 x H 740	3 368	7 075
		W 1600 x D 800 x H 740	3 607	7 574
		W 1800 x D 800 x H 740	3 891	8 171
U1 Double workstations D1440 / 1640		W 1400 x D 1440 x H 740	5 268	11 062
		W 1600 x D 1440 x H 740	5 647	11 858
		W 1400 x D 1640 x H 740	5 647	11 858
		W 1600 x D 1640 x H 740	6 122	12 854
U1 Quadruple workstations D1440 / 1640		W 2800 x D 1440 x H 740	10 203	21 417
		W 3200 x D 1440 x H 740	10 962	23 925
		W 2800 x D 1640 x H 740	10 962	23 018
		W 3200 x D 1640 x H 740	11 910	25 012
U1 Supplementary units work- stations D1440 / 1640		W 1400 x D 1440 x H 740	4 888	10 263
		W 1600 x D 1440 x H 740	5 268	11 062
		W 1400 x D 1640 x H 740	5 218	10 962
		W 1600 x D 1640 x H 740	5 694	11 958
U1 Meeting table W1200		W 1200 x D 1200 x H 740	4 366	10 149







U1 Plane Table

		White / Light grey / Anthracite melamine	White HPL Black linoleum Oak veneer
U1 Meeting table W2000		W 2000 x D 1000 x H 740 6 975	16 217
U1 High table W1600		W 1600 x D 700 x H 1050 3 938	12 209
U1 High table W1800		W 1800 x D 700 x H 1050 4 555	14 121

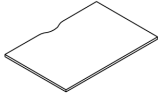
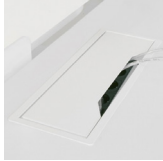

U1 Plane Table Upcharges & Accessories

		Dimension	Black / white	Price
U1 Bow shaped cut out for cables				413
U1 Cable cut out inc metall cable door		W 320 x D130 x H 25	*	537
U1 Cable tray for single desks in metal		W 1080 x D 180 x H110	*	578
U1 Cable tray for double desks in metal		W 1100 x D 435 x H 130	*	1 320
U1 Sliding desktop Inc cable tray in metal		Only suitable for 1400 and 1600 mm desktops, single and benches Colour as desktop	*	1 238
U1 Upcharge for adjustable legs		Manual adjustable legs 620 - 850 mm NB! Only for single desks		1 485



A1 Angled Table



With its rational construction, angled legs and the desktop appearing as if floating on the base, the A1 Angled table has a strong, graphical character.

A1 Angled table allows for an extensive array of possibilities – including desks, shared workstations and meeting tables.



A1 Angled Table - Technical details

Tabletop

Melamine versions are made in 25 mm MFC board with straight ABS edges. The HPL, linoleum and oak veneer versions are made in 25 mm MDF board with either straight edges or chamfered front.

Choose between the following tabletop alternatives:

- White melamine with white ABS edge
- Grey melamine with grey ABS edge
- Anthracite melamine with anthracite ABS edge
- White HPL with white ABS edge
- Black linoleum with black lacquered MDF edge
- Oak veneer with 2 mm solid oak edge



Choose edging: (only for HPL, linoleum and oak veneer versions)

- Straight edges
- Chamfered front:

Base

The legs are made from metal tubes - 40x40x2 mm in powder coated metal. Metal to metal connections secure easy and quick assembly / disassembling. All legs have plastic feet with height levelling (+10 mm)

Choose between the following base colours:

- White
- Grey
- Anthracite
- Black





A1 Angled Table - Technical details

Cable Cutouts

Choose between the following cutout alternatives:

- No cutout
- Bowshaped cutout in the back
- Cutout for metal cable, centered / back (desks only)
- Cutout for metal cable door in the absolute centre (meeting tables only)
- Sliding desktop (desks only)

Specials

For projects sizes, materials and finishes may be customized to fit specific needs. Please inquire for pricing, minimum quantities and lead times.

Forbo Desktop Linoleum:



Melamine & HPL:



Veneers:











Valchromat:



Please refer to the appendix for further details and images of custom surfaces.







A1 Angled Table

		Dimension	White / Light Grey / Anthracite melamine	White HPL Black linoleum Oakveneer
A1 Single desk D600		W 1200 x D 600 x H 740	2 943	5 480
		W 1400 x D 600 x H 740	2 989	5 878
A1 Single desk D700		W 1400 x D 700 x H 740	3 227	6 079
		W 1600 x D 700 x H 740	3 417	6 377
		W 1800 x D 700 x H 740	4 127	7 673
A1 Single desk D800		W 1400 x D 800 x H 740	3 417	6 477
		W 1600 x D 800 x H 740	3 653	6 875
		W 1800 x D 800 x H 740	3 938	7 274
A1 Double workstations D1440 / 1640		W 1400 x D 1440 x H 740	5 268	10 263
		W 1600 x D 1440 x H 740	5 647	10 861
		W 1400 x D 1640 x H 740	5 884	11 658
		W 1600 x D 1640 x H 740	6 358	12 256
A1 Quadruple worksta- tions D1440 / 1640		W 2800 x D 1440 x H 740	10 439	19 231
		W 3200 x D 1440 x H 740	11 198	20 427
		W 2800 x D 1640 x H 740	11 151	20 726
		W 3200 x D 1640 x H 740	12 100	22 321
A1 Supplementary units workstations D1440 / 1640		W 1400 x D 1440 x H 740	4 888	8 967
		W 1600 x D 1440 x H 740	5 268	9 566
		W 1400 x D 1640 x H 740	5 220	9 666
		W 1600 x D 1640 x H 740	5 694	10 463
A1 Meeting table W1200		W 1200 x D 1200 x H 740	5 552	10 856
A1 Meeting table W2000		W 2000 x D 1000 x H 740	7 545	14 232

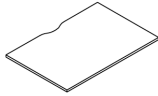

A1 Angled Table

	Dimension	Black / White	Price
A1 Bow shaped cut out for cables			474
A1 Cable cut out inclu- ding cable door in metal		*	617
A1 Cable tray for single desks in metal		*	664
A1 Cable tray for dou- ble desks in metal		*	1 518



HI Table - Technical details

Tabletop

25 mm MFC board with ABS edging or solid oak edging (only oak veneer version) .

Choose between the following tabletop alternatives:

- White melamine with white ABS edge
- Grey melamine with grey ABS edge
- Anthracite melamine with anthracite ABS edge
- White HPL with white ABS edge
- Black linoleum with black ABS edge
- Oak veneer with 2 mm solid oak edge



Base

The sides follow the colour of the tabletop. The footrest is a lacquered 35x2 mm steel tube. Plastic legs with height adjustable support (+10 mm)

Choose footrest powder coating colour:

- White
- Grey



Specials

For projects sizes, materials and finishes may be customized to fit specific needs. Please inquire for pricing, minimum quantities and lead times.

Forbo Desktop Linoleum:



Melamine & HPL:



Veneers:





Valchromat:



Please refer to the appendix for further details and images of custom surfaces.



HI Table

		White / Light grey / Anthracite melamine	White HPL Black linoleum Oak veneer
HI 01 W1600		W 1600 x D 700 x H 1050 7 948	16 932
HI 02 W1800		W 1800 x D 700 x H 1050 8 423	18 368



W1 Wired Table



The Wired Table is a contemporary take on a classical modernist theme. With a simple and elegant leg construction in thin steel rod, the table gives a light and airy impression while retaining constructive strength and stability.

Available both in a desk- and a meeting table version, The Wired Series has a strong graphical character that will appeal as much to the dining room or home office, as to the workspace.



W1 Wired Table - Technical details

Tabletop

Melamine versions are made in a 25 mm MFC board. The HPL, linoleum and oak veneer versions are made in 25 mm MDF board. Choose between the following tabletop alternatives:

- White melamine with white ABS edge
- Anthracite melamine with anthracite ABS edge
- White HPL with white ABS edge
- White HPL with white lacquered MDF edge(10 mm)
- Black linoleum with black lacquered MDF edge (10 mm)
- Oak veneer with 2 mm solid oak edge



Base

The steel base is powder coated white or, at a given upcharge, black. Metal to metal connections secure easy and quick assembly / disassembling

Choose between the following base finishes:

- White
- Black



Specials

For projects sizes, materials and finishes may be customized to fit specific needs. Please inquire for pricing, minimum quantities and lead times.

Forbo Desktop Linoleum:



Melamine & HPL:



Veneers:



Valchromat:



Please refer to the appendix for further details and images of custom surfaces.



W1 Wired Table - Technical details

Cable management







The W1 desks and meeting tables are offered with our standard cable door in metal. For the MDF table it is also possible to get a cable door in the same finish as the tabletop at a given upcharge.

Choose between the following cutout alternatives:

- No cutout
- Cutout for metal cable door in the middle back (workstations)
- Cutout for metal cable door to the left /back (workstations)
- Cutout for metal cable door to the right /back (workstations)
- Cutout for metal cable door, centred (meeting tables)
- Cutout with cable door in tabletop material, centred (HPL, linoleum and oak veneer meeting tables only)

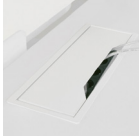

W1 Wired Table

		White / Grey / Anthracite melamine	White HPL Black linoleum Oak veneer
W1 desktop W1600		W 1600 x D 800	4 935 10 363
W1 desktop W1800		W 1800 x D 800	5 366 11 270
W1 Conference table W2200		W 2200 x D 1300	10 363 21 604
W1 Cable door in metal		W 320 x D 130 x H 25	617
W1 Cable tray in metal		W 1080 x D 180 x H 110	664
W1 Cable tray in metal for meeting table		W 1100 x D 435 x H 130	1 518
W1 Cable door in finish as desktop material		Only available with HPL, linoleum and veneer	2 143
W1 Double Cable door in finish as desktop material		Only available with HPL, linoleum and veneer	2 756



E1 Height Adjustable Table



The E1 series is our classical minimalist electrical table system, built on a double set of strong, silent motors made by Linak.

The T-shaped base is designed to be as light and simple as possible without compromising with stability and the desk's main task: to lift your table top silently and effortlessly every time.



E1 Height Adjustable Table - Technical details

Tabletops

Melamine versions are made in a 25 mm MFC board. The HPL, linoleum and oak veneer versions are made in 25 mm MDF board. All versions have sharp corners as a standard, but tables with chamfered MDF edges may be ordered with rounded corners in a radius of 15 mm.

Choose between the following tabletop alternatives:

- White melamine with straight, white ABS edge
- Grey melamine with straight, grey ABS edge
- Anthracite melamine with straight, anthracite ABS edge
- White HPL with straight, white ABS edge
- White HPL with chamfered, white lacquered MDF edge
- Black linoleum with chamfered, black lacquered MDF edge
- Oak veneer with straight, solid oak edge



For the MDF edge versions, choose between the following corner treatments:

- Sharp corners
- Rounded corners

Base

The E1 table is equipped with double motors from Linak. The standard column lifts from H 705-1205. At an upcharge a 3-part column can be offered, lifting from H610-1260. Both types have the lifting capacity of 80 kg. Soft stop and soft start. Low noise-level. Extremely low power consumption in standby mode: 0,1 W.

Choose between the following powder coated base finishes;

- White
- Grey
- Black

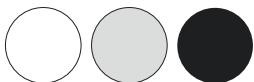



E1 Height Adjustable Table - Technical details

Specials

For projects sizes, materials and finishes may be customized to fit specific needs. Please inquire for pricing, minimum quantities and lead times.

Forbo Desktop Linoleum:

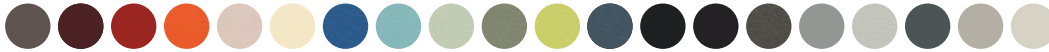

Melamine & HPL:



Veneers:



Valchromat:



Please refer to the appendix for further details and images of custom surfaces.







Cable management

Choose between the following cutout alternatives:

- No cutout
- Cutout for metal cable door in the middle
- Cutout for metal cable door to the left
- Cutout for metal cable door to the right



E1 Height Adjustable Table

		White / Grey Anthracite melamine	White HPL Black linoleum Oak veneer
E1 Single desk W1400		W 1400 x D 800 x H 705 / 1205	10 176
E1 Single desk W1600		W 1600 x D 800 x H 705 / 1205	10 286
E1 Single desk W1800		W 1800 x D 800 x H 705 / 1205	10 691
E1 Twin desk W1600		W 1600 x D 1640 x H 705 / 1205	21 306
E1 Cable door in metal		W 320 x D 130 x H 25	617
E1 Cable tray in metal		W 1080 x D 180 x H 110	664
E1 Drawer in metal with felt inline		W 584 x D 290 x H 50	2 325
Upcharge for 3-part columns (H 610-1260)			1 331



E3 Height Adjustable Tables



The E3 is our entry-level electrical table – offering the minimalist Elementa look at a great price.

Ran by a strong single motor, the E3 T-base is the simplest conceivable construction to elegantly and steadily support you throughout your workday, whether you are sitting or standing.



E3 Height Adjustable Tables - Technical details

Tabletops

Melamine versions are made in a 25 mm MFC board. The HPL, linoleum and oak veneer versions are made in 25 mm MDF board. All versions have sharp corners as a standard, but tables with chamfered MDF edges may be ordered with rounded corners in a radius of 15 mm.

Choose between the following tabletop alternatives:

- White melamine with straight, white ABS edge
- Grey melamine with straight, grey ABS edge
- Anthracite melamine with straight, anthracite ABS edge
- White HPL with straight, white ABS edge
- White HPL with chamfered, white lacquered MDF edge
- Black linoleum with chamfered, black lacquered MDF edge
- Oak veneer with straight, solid oak edge



For the MDF edge versions, choose between the following corner treatments:

- Sharp corners
- Rounded corners

Base

The E3 table is equipped with a single motor with the capacity to lift 40 kg and with a stroke of 490 mm (H 705-1195). Extremely low power consumption in standby mode: 0,06 W

Choose between the following powder coated finishes;

- White
- Grey
- Black

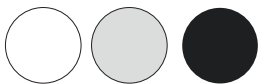

Other finishes may be available upon request and at a given upcharge and minimum order.



E3 Height Adjustable Tables - Technical details

Specials

For projects sizes, materials and finishes may be customized to fit specific needs. Please inquire for pricing, minimum quantities and lead times.

Forbo Desktop Linoleum:



Melamine & HPL:



Veneers:



Valchromat:



Please refer to the appendix for further details and images of custom surfaces.







Cable management

Choose between the following cutout alternatives:

- No cutout
- Cutout for metal cable door in the middle
- Cutout for metal cable door to the left
- Cutout for metal cable door to the right

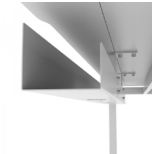

E3 Height Adjustable Tables

		White / Grey / Anthracite melamine	White HPL Black linoleum Oak veneer
E3 Electric height adjustable W1400		W 1400 x D 800 x H 705 / 1195	8 669 15 605
E3 Electric height adjustable W1600		W 1600 x D 800 x H 705 / 1195	8 854 15 937
E3 Manual height adjustable W1400		W 1400 x D 800 x H 620 / 850	5 363 9 653
E3 Manual height adjustable W1600		W 1600 x D 800 x H 620 / 850	5 504 9 908
E3 Cable door in metal		W 320 x D 130 x H 25	617
E3 Cable tray in metal		W 1080 x D 180 x H 110	664
E3 Drawer in metal with felt inline		W 584 x D 290 x H 50	2 420



MU Acoustic Panels



MU is a series of minimalist panels that can be configured to elegantly control the acoustics of any room.

With 6 differently sized rectangular and square shapes, 2 thicknesses - and lots of colour options, the possibilities for expression are really endless.



MU Acoustic Panels - Technical details

One-sided ceiling panels and one-sided wall panels

Acoustical panels in 8 square and rectangular sizes. Frames made of 30 mm plywood covered with acoustic foam and upholstered with wool fabric. Certificated sound absorber - class C

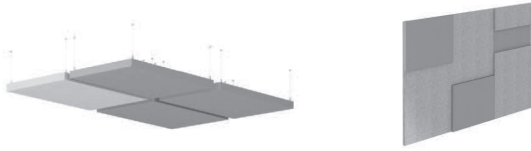

Double-sided ceiling panels

Frames made of 18 mm plywood covered with acoustic foam and upholstered with fabric. Certificated sound absorber - class C.



Rating of sound absorption, calculated in acc. with LST EN ISO 11654:1998

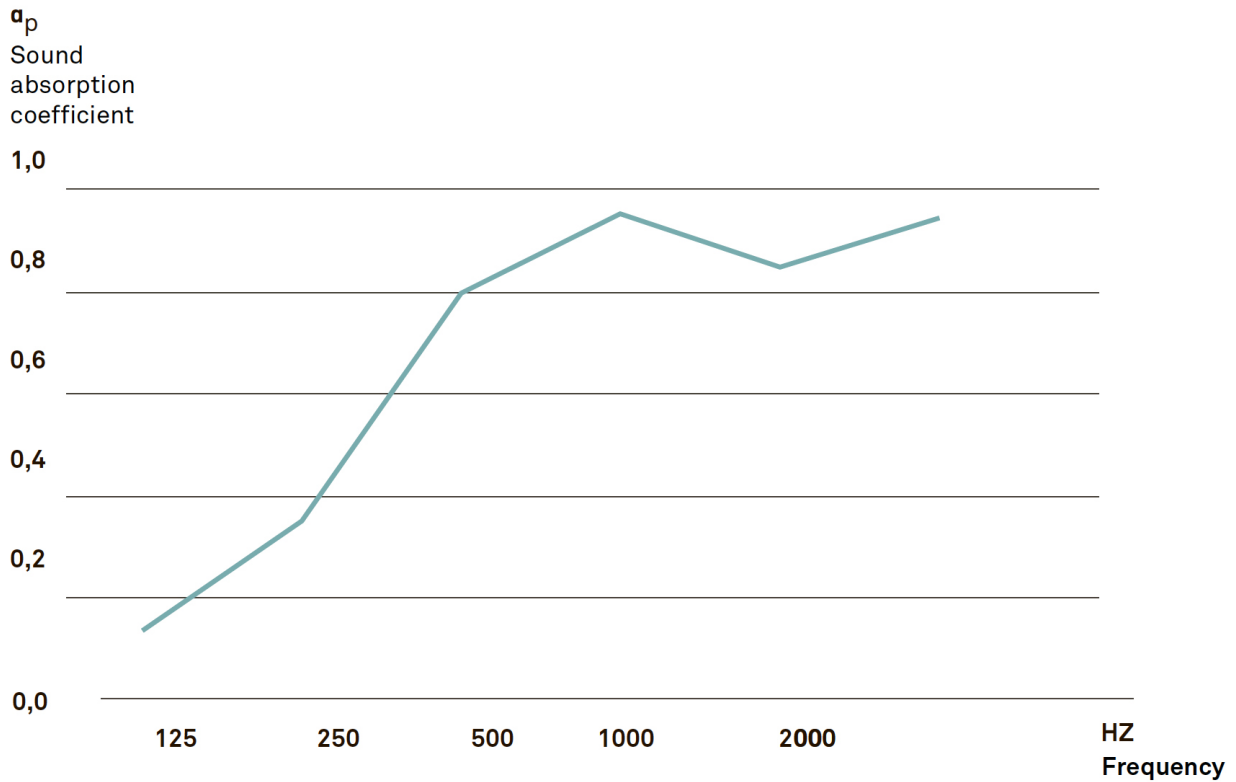

Weighted sound absorption coefficient: $\alpha_w = 0,65$ (MH)



MU Acoustic Panels - Technical details

MU Measures

Single-sided panels for walls and ceilings.

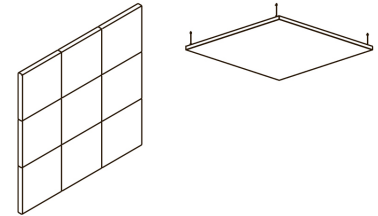
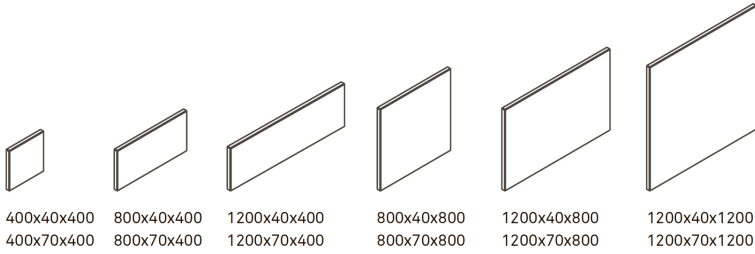

Double-sided panels for room dividers

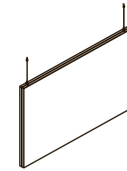
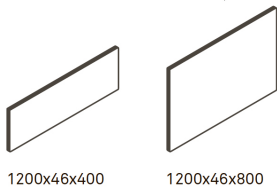

MU Fittings

- Drilled to the wall fittings;
- Adhesive fittings (for glass or quick assembly);
- Connection components for the panels of the same length;
- Ceiling panels suspension set (50-3000 mm);
- Double-sided (vertical) panels suspension set (50-3000 mm);
- Double-sided (vertical) panels suspension set for interconnect (50-1200 mm).

Wall panels connection example with fittings

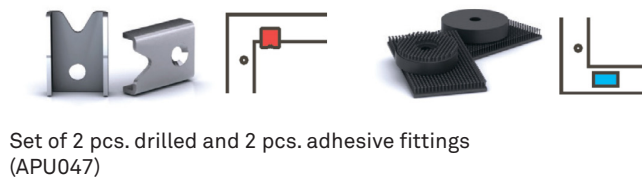
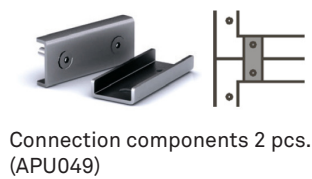
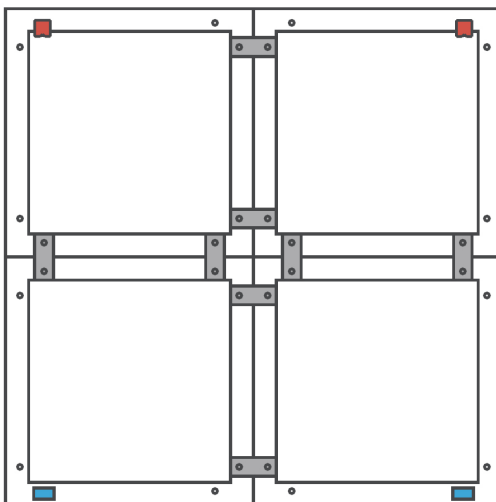

APU040(4) + APU047(1) + APU049(4)



MU Acoustic Panels- Technical details

Fabrics for Screens

Please see the appendix for details and larger samples of the standard materials offered for screens.

Velito Presto







Camira Synergy





MU Acoustic Panels - Vertical 2-sided

		Dimension	
MU1 01 Suspended low panel H400		W 1200 x D 46 x H 400. 3,12 kg / pcs	3 820
MU1 02 Suspended high panel H800		W 1200 x D 46 x H 800. 4,8 kg / pcs	6 796
MU1 03 Wire pr panel L1200		L 1200	297
MU1 04 Wire pr panel L3000		L 3000 Max 10 kg load	496
MU1 05 Connection wire pr panel L1200		L 1200 Max 10 kg load	248

Please refer to the appendix to see the available standard fabrics.











MU Acoustic Panels - Wall and Ceiling

		Dimension	
MU2 01 Wall panel, thin W400		W 400 x D 40 x H 400	1 439
		1,06 kg / pcs	
MU2 02 Wall panel, thick W400		W 400 x D 70 x H 400	1 786
		2,02 kg / pcs	
MU2 03 Wall panel, thin W800		W 800 x D 40 x H 400	2 182
		1,8 kg / pcs	
MU2 04 Wall panel, thick W800		W 800 x D 70 x H 400	2 778
		3,1 kg / pcs	
MU2 05 Wall panel, thin W1200		W 1200 x D 40 x H 400	2 927
		2,46 kg / pcs	
MU2 06 Wall panel, thick W1200		W 1200 x D 70 x H 400	3 820
		4,46 kg / pcs	
MU2 07 Wall panel, thin W800		W 800 x D 40 x H 800	4 464
		2,64 kg / pcs	
MU2 08 Wall panel, thick W800		W 800 x D 70 x H 800	5 804
		4,76 kg / pcs	

Please refer to the appendix to see the available standard fabrics.



MU Acoustic Panels - Wall and Ceiling (cont.)

		Dimension	
MU2 09 Wall panel, thin W1200		W 1200 x D 40 x H 800	5 203
		3,84 kg / pcs	
MU2 10 Wall panel, thick W1200		W 1200 x D 70 x H 800	6 787
		6,04 kg / pcs	
MU2 11 Wall panel, thin W1200		W 1200 x D 40 x H 1200	9 524
		4,54 kg / pcs	
MU2 12 Wall panel, thick W1200		W 1200 x D 70 x H 1200	12 353
		7,88 kg / pcs	
MU2 20 Fitting 4 pcs		Adhesive fittings for wall panels (4 pcs.). Unsuitable for conneced compositions. Can support a load of 4 kg	447
MU2 21 Drilled fittings 2 pcs		Set of drilled and adhesive fittings for wall panels (2 pcs. of each). Recommended load up to 20 kg.	447
MU2 22 Panel connector 2 pcs		Panels connection components for the same length sides panels (2 pcs.). Recommended composition weight up to 20 kg or 4 panels.	199
MU2 23 Set of 4 wires		Suspensions for ceiling (horizontal) panels (4pcs.). Suitable for masonry/gypsum surface.	596
MU2 24 Set of 4 wires		Suspensions for ceiling (horizontal) panels (4pcs.). Suitable for masonry/gypsum surface.	1 091

Please refer to the appendix to see the available standard fabrics.



UM Acoustic Screens

Core

Acoustic screens have a special sound absorbing core and can be used with all Elementa desk systems, for long and short sides. The screens have a core of 16 mm raw chipboard, 10 mm acoustic foam, and are covered with fabric, giving a total thickness of 36 mm.

For documentation of test-results of acoustic effects, please inquire.

When ordering, specify code, size, desk type and fabric. Please also specify which desk model you will fit the screen.

Fabrics

Please see the appendix for details and larger samples of the standard materials offered for screens.

Category 1: Velito Presto













Category 2: Camira Synergy











UM Acoustic Screens for All Desktops

		Dimension	
ASD 01 Side Screens W 700		W 700 x D 36 x H 595 (530)	1 668
ASD 02 Side Screens W 800		W 800 x D 36 x H 595 (530)	1 970
ASD 03 Screens W 1200		W 1200 x D 36 x H 595 (530)	3 031
ASD 04 Screens W 1400		W 1400 x D 36 x H 595 (530)	3 233
ASD 05 Screens W 1600		W 1600 x D 36 x H 595 (530)	3 333
ASD 06 Screens W 1800		W 1800 x D 36 x H 595 (530)	4 091
ASD 07 Screens for benches W 1200		W 1200 x D 36 x H 555 (530)	2 980
ASD 08 Screens for benches W 1400		W 1400 x D 36 x H 555 (530)	3 081
ASD 09 Screens for benches W 1600		W 1600 x D 36 x H 555 (530)	3 132
ASD 10 Screens for benches W 1800		W 1800 x D 36 x H 555 (530)	4 040



UM Acoustic Screens for All Desktops

		Dimension	
ASD 11 Center screens W 700 Set of 2 pcs		W 700 x D 36 x H 555 (530)	3 990
ASD 12 Center screens W 800 Set of 2 pcs		W 800 x D 36 x H 555 (530)	4 849
ASD 13 End screen Left side of desktop W 1000		W 1000 x D 36 x H 1270 (530)	5 304
ASD 14 End screen Right side of desktop W 1000		W 1000 x D 36 x H 1270 (530)	5 304
ASD 20 Screen for height adj desktop W 1400		W 1400 x D 36 x H 760 (530)	3 890
ASD 21 Screen for height adj desktop W 1600		W 1600 x D 36 x H 760 (530)	4 142
ASD 22 Sidescreen for height adj desktop W 800		W 800 x D 36 x H 760 (530)	3 031



UM Free Standing acoustical Screens

Core

The Free Standing acoustical screens have a special sound absorbing core and can be mounted on either legs or castors. It is possible to connect screens of the same or different sizes through the use of linking devices.

The screens have a core of 16 mm raw chipboard, 10 mm acoustic foam, and are covered with fabric, giving a total thickness of 36 mm.

For documentation of test-results of acoustic effects, please inquire

When ordering, specify code, size and fabric.

Metal Parts

For the metal parts, please choose between the following powder coated finishes:

- White
- Black
- Grey
- Anthracite



Fabrics

Please see the appendix for details and larger samples of the standard materials offered for screens.

Category 1: Velito Presto











Category 2: Camira Synergy





UM Freestanding Acoustic Screens

		Dimension	
FAS 10 Screen W 800 Ex feet (add separately)		W 800 x D 36 x H 1200	3 941
FAS 11 Screen W 800 Ex feet (add separately)		W 800 x D 36 x H 1400	4 091
FAS 12 Screen W 800		W 800 x D 36 x H 1600	4 243
FAS 13 Screen W 800 Ex feet (add separately)		W 800 x D 36 x H 1800	7 325
FAS 20 Screen W 1000 Ex feet (add separately)		W 1000 x D 36 x H 1200	5 102
FAS 21 Screen W 1000 Ex feet (add separately)		W 1000 x D 36 x H 1400	5 152
FAS 22 Screen W 1000 Ex feet (add separately)		W 1000 x D 36 x H 1600	5 254
FAS 23 Screen W 1000 Ex feet (add separately)		W 1000 x D 36 x H 1800	7 626











UM Freestanding Acoustic Screens

		Dimension	
FAS 30 Screen W 1200 Ex feet (add separately)		W 1200 x D 36 x H 1200	5 961
FAS 31 Screen W 1200 Ex feet (add separately)		W 1200 x D 36 x H 1400	6 062
FAS 32 Screen W 1200 Ex feet (add separately)		W 1200 x D 36 x H 1600	6 162
FAS 33 Screen W 1200 Ex feet (add separately)		W 1200 x D 36 x H 1800	7 981
FAS 41 Screen W 1400 Ex feet (add separately)		W 1400 x D 36 x H 1200	6 012
FAS 42 Screen W 1400 Ex feet (add separately)		W 1400 x D 36 x H 1400	6 971
FAS 43 Screen W 1400 Ex feet (add separately)		W 1400 x D 36 x H 1600	7 072
FAS 44 Screen W 1400 Ex feet (add separately)		W 1400 x D 36 x H 1800	8 334

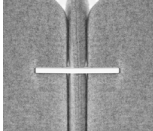

UM Freestanding Acoustic Screens

		Dimension	
FAS 50 Screen W 1600 Ex feet (add separately)		W 1600 x D 36 x H 1200	6 113
FAS 51 Screen W 1600 Ex feet (add separately)		W 1600 x D 36 x H 1400	7 072
FAS 52 Screen W 1600 Ex feet (add separately)		W 1600 x D 36 x H 1600	7 981
FAS 53 Screen W 1600 Ex feet (add separately)		W 1600 x D 36 x H 1800	8 688
FAS 90 Set of 2 metal legs		White metal	1 262
FAS 91 Set of 2 metal legs on castors		White metal, black castors	2 122
FAS 92 Connecting component for screens (2 pcs)		White metal 1 set required to connect 2 screens.	202
FAS 93 Connecting component for screens (2 pcs)		White metal 1 set required to connect 2 screens.	253
FAS 94 Connecting component for screens (2 pcs)		White metal 1 set required to connect 2 screens.	354



NO Desk Screens





NO Desk Screens - Technical Data

Core

The Screens can be used with all Elementa desk systems, for the short and long sides. Regular screens have a core in 12 mm chipboard with 3 mm foam on each side and are covered with fabric, giving a total thickness of 22 mm

When ordering, specify code, size and height where applicable and fabric. Please also specify which desk model you will fit the screen to, including the thickness of the table top, if to be fit with a non-standard table.

Fabrics

Please see the appendix for details and larger samples of the standard materials offered for screens.

Category 1: Velito Presto







Category 2: Camira Synergy





NO Desk Screens

		Dimension	
SAD 01 Screen for single desk W1200		W 1200 x D 22 x H 350 / 450	2 575
SAD 02 Screen for single desk W1400		W 1400 x D 22 x H 350 / 450	2 828
SAD 03 Screen for single desk W1600		W 1600 x D 22 x H 350 / 450	3 233
SAD 04 Screen for single desk W1800		W 1800 x D 22 x H 350 / 450	3 535
SAD 05 Sidescreen for single desk W700		W 700 x D 22 x H 350 / 450	1 516
SAD 06 Sidescreen for single desk W800		W 800 x D 22 x H 350 / 450	1 516
SAD 07 Screen for bench W1200		W 1200 x D 22 x H 350 / 450	2 476
SAD 08 Screen for bench W1400		W 1400 x D 22 x H 350 / 450	2 879
SAD 09 Screen for bench W1600		W 1600 x D 22 x H 350 / 450	3 233
SAD 10 Screen for bench W1800		W 1800 x D 22 x H 350 / 450	3 485



NO Desk Screens

SAD 11
Central Screen
Double desk
W 700



Dimension

W 700 x D 22 x H 350 / 450 1 617

SAD 12
Central Screen
Double desk
W 800



W 800 x D 22 x H 350 / 450 2 021

SAD 13
End screen for
double bench
H1090



W 1640 x 22 x H 1090 5 455

SAD 14
Set of screens for
quadruple bench
D700 x H35/H45



W 1200 x 710 x D 22 x H 350/450 8 183

W 1400 x 710 x D 22 x H 350/450 8 991

W 1600 x 710 x D 22 x H 350/450 9 699

W 1800 x 710 x D 22 x H 350/450 10 204

SAD 15
Set of screens for
quadruple bench
D800 x H35/H45



W 1200 x 810 x D 22 x H 350/450 8 991

W 1400 x 810 x D 22 x H 350/450 9 799

W 1600 x 810 x D 22 x H 350/450 10 506

W 1800 x 810 x D 22 x H 350/450 11 012



NO Desk Screens

SAT 01
Screen
W 1600



Dimension

W 1600 x D 22 x H750 (360)

3 702



O2 Straight Storage



The O2 Straight Storage features essentialist versions of classical workspace storage typologies. In this precisely executed series, you will find simple and elegant cabinets, shelves, mobile pedestals and more. While free of any extraneous details, the Straight Storage series are all well tested and well thought-out pieces of furniture with all features you will need to keep your paper and stuff organised in style.



O2 Straight Storage - Technical Details

Carcass

Carcass and doors are made in 18 mm MFC board with 1,5 mm ABS edges. Veneer versions are made in chipboard with 1,5 mm solid oak edges. All cabinets have height levelling feet (23 mm +10). Mobile pedestals have black castors. As a standard, cabinets are made with locks. It is possible to order all cabinets without locks, please specify if needed. The mobile pedestals have central locks, locking all drawers with one key.

Choose between the following finishes:

- White
- Grey
- Anthracite
- Oak veneer



Handles

Handles are in powder coated steel.

Choose between the following finishes:

- White
- Grey
- Anthracite
- Black



Specials

For projects sizes, materials and finishes may be customized to fit specific needs. Please inquire for pricing, minimum quantities and lead times.

Forbo Desktop Linoleum:



Melamine & HPL:



Veneers:



Valchromat:



Please refer to the appendix for further details and images of custom surfaces..











O2 Straight Storage

		White, Grey, Anthracite Melamine	Oak veneer
O2 straight 10 Sliding doors Lockable W 1440		5 512	11 573
O2 straight 11 Sliding doors Lockable W 1640		7 640	16 042
O2 straight 12 Sliding doors Lockable W 1440		6 930	14 554
O2 straight 13 Sliding doors Lockable W 1640		8 512	17 877
O2 straight 20 Doors Lockable W 800		4 092	8 594
O2 straight 21 Doors Lockable W 800		5 129	10 771
O2 straight 22 Doors Lockable W 800		6 384	13 408
O2 straight 23 Doors Lockable W 800		9 986	20 970
O2 straight 24 Doors Lockable W 1440		8 458	17 762
O2 straight 25 Doors Lockable W 1640		8 895	18 679







O2 Straight Storage

		White, Grey, Anthracite Melamine	Oak veneer	
O2 straight 30 Doors Lockable W 1440		W 1440 x D 400 x H 1085	10 641	22 345
O2 straight 31 Doors Lockable W 1640		W 1640 x D 400 x H 1085	11 295	23 720
O2 straight 40 6 doors Lockable W 800		W 800 x D 360 x H 1092 6 doors Lockable	10 531	22 116
O2 straight 41 8 doors Lockable W 800		W 800 x D 360 x H 1444	13 587	28 533
O2 Tower 01 Pull out storage 2 shelves + pencil tray Lockable Left / right		W 800 x D 402 x H 741	7 787	16 354
O2 Tower 02 Pull out storage 3 shelves Lockable Left / right		W 800 x D 400 x H 1090	11 151	23 417
O2 Tower 03 Pull out storage 3 shelves + pencil tray Lockable Left / right		W 800 x D 400 x H 1200	11 387	23 915
O2 Fixed pedestal 2 drawers Lockable W 428		W 428 x D 600 x H 410	2 946	6 189









O2 Straight Storage

		White, Grey, Anthracite Melamine	Oak veneer	
O2 Straight 50 Open cabinet W800		W 800 x D 340 x H 740	2 019	4 241
O2 Straight 51 Open cabinet W800		W 800 x D 340 x H 1092	2 564	5 387
O2 Straight 52 Open cabinet W800		W 800 x D 340 x H 1444	3 329	6 991
O2 Straight 60 Double sided bookcase		W 1600 x D 340 x H 1092	4 583	9 625



O2 Straight Storage

		White, Grey, Anthracite Melamine	Oak veneer
O2 Small mobile pedestal 01 W 298		W 298 x D 600 x H 560 3 drawers Lockable	3 710 7 792
O2 Small mobile pedestal 02 W 298		W 298 x D 600 x H 560 2 drawers 1 file drawer Lockable	4 092 8 594
O2 wide mobile pedestal 03 W 428		W 428 x D 600 x H 560 3 drawers Lockable	3 874 8 137
O2 wide mobile pedestal 04 W 428		W 428 x D 600 x H 560 2 drawers 1 file drawer Lockable	4 202 8 823
O2 pedestal 01 W 430		W 430 x D 600 x H 740 3 drawers Lockable	4 857 10 198
O2 pedestal 02 W 430		W 430 x D 600 x H 740 3 drawers 1 file drawer Lockable	5 184 10 887
O2 cushion for pedestal Hook and loop		W 420 x D 590 Available on cat. 1 fabric: Velito	1 856

Please refer to the appendix to see fabric swatches for the O2 cushion.



Derive

Design: Emma Staubo & Jomi Evers

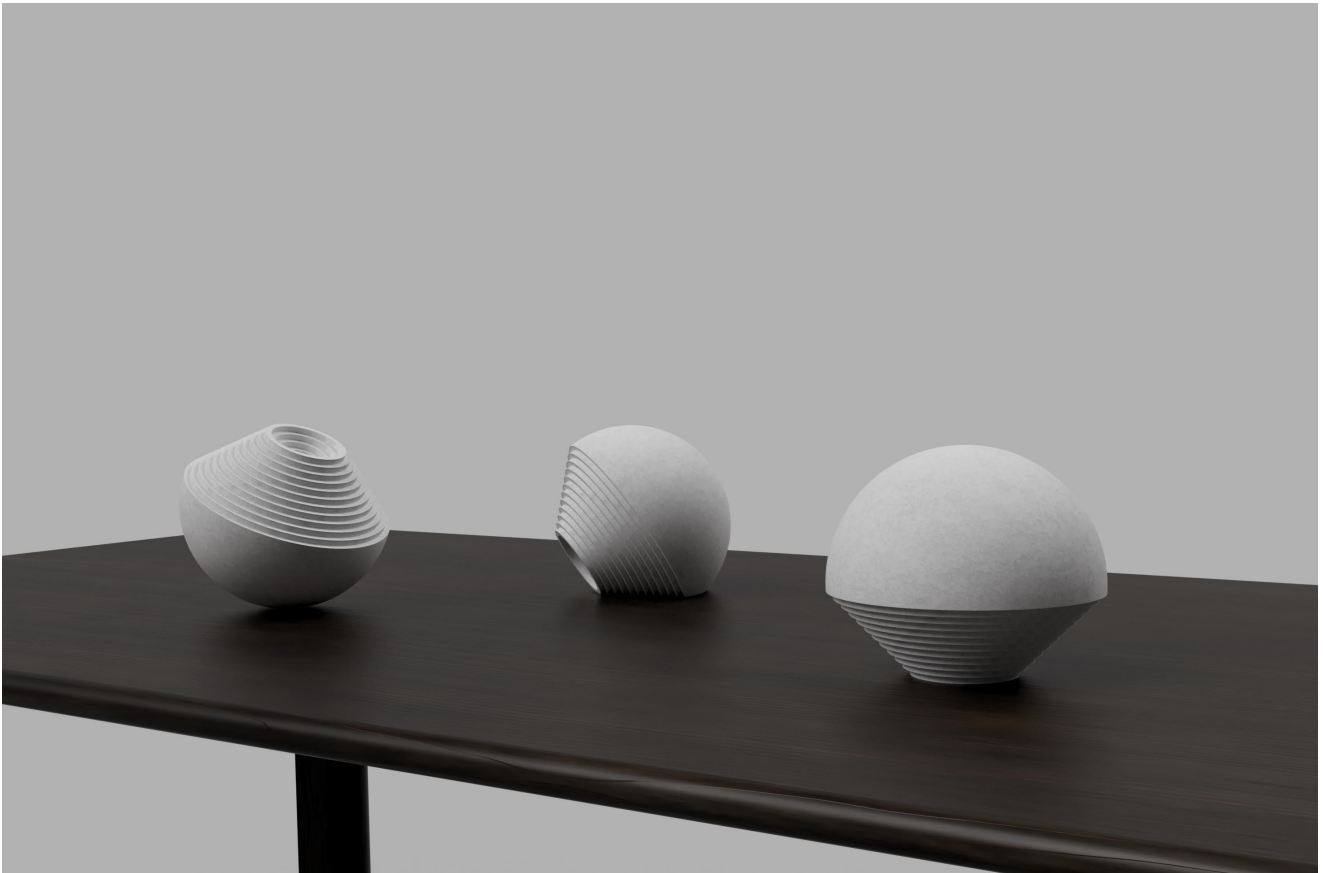

The Derive by Emma Staubo & Jomi Evers is a "Boundary Being" that has emerged from the field where the forest meets the digital realm.

Just touch the Derive gently to allow yourself to drift into a lush soundscape transmitted from a listening station placed deep into a Norwegian forest.



Derive

Design: Emma Staubo & Jomi Evers

**Derive site specific
installation +
receivers**



Dimension

Price on request



Standard Surfaces

Finishes for our standard collections of tabletops, storage and metal parts. Please see the individual product presentations to see where the various surfaces apply.

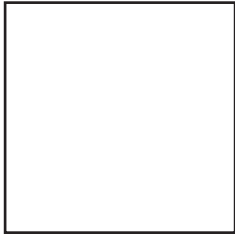

White melamine / HPL
RAL 9016

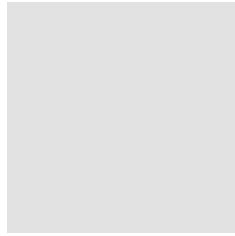

Light Grey Melamine
RAL 7035



Anthracite Melamine
RAL 7016



Black Linoleum
NCS S 9000-N



Ash Linoleum
NCS S 5502-G

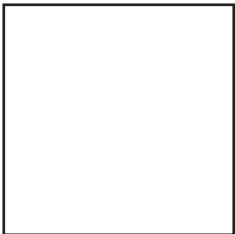

White Metal
RAL 9016

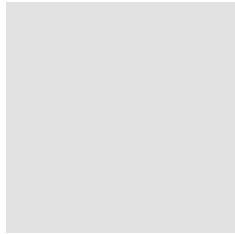

Grey Metal
RAL 7035



Anthracite Metal
RAL 7016



Black Metal
RAL 9005



Red Metal (ON tables)
RAL 3003

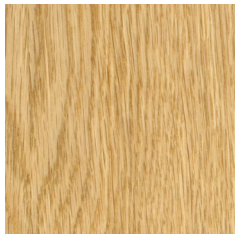

Natural Oak veneer

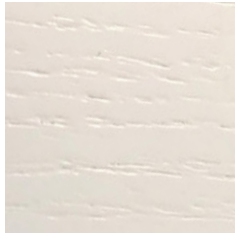

White Painted Oak
(ON Tables)

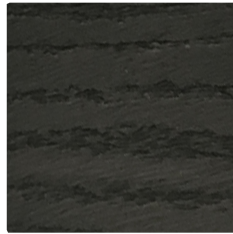

Black Painted Oak
(ON Tables)



Red Painted Oak
(ON Tables) RAL 3003



Black Metal (ON Ta-
bles) : RAL 9017)



Fabrics For Screens: Velito

Composition: 88% Wool, 12% Polyamide. Abrasion resistance: 120.000 Martindale cycles



GZ1 - Black

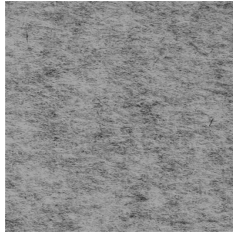

GZ2 - Grey melange

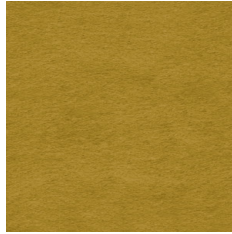

GZ3 - Mustard



GZ4 - Beige



GZ5 - Red melange



GZ6 - Blue



GZ8 - Brown melange



GZ9 - Dark Grey



GS0 - Green melange



GS1 - Light blue



GS2 - Grey

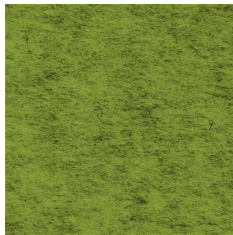

GS3 - Light green melange



GS4 - Cappuccino



GS5 - Light red



GS6 - Mint

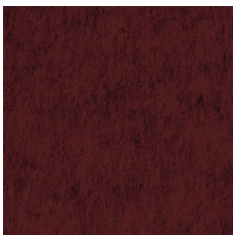

GS7 - Claret melange

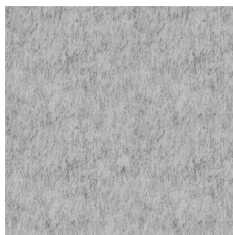

GS8 - Light grey melange

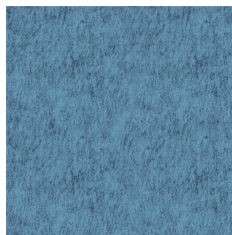

GS9 - Light blue melange

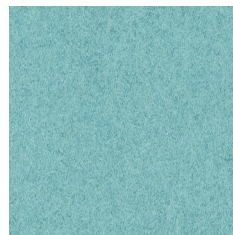

GC1 - Light mint



GC3 - Yellow



GC5 - Dark pink melange



Fabrics For Screens: Synergy by Camira

Composition: 95% virgin wool , 5% polyamid. 100 000 Martindale cycles.

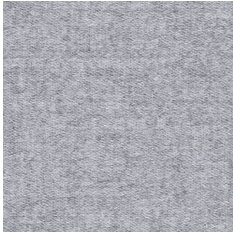

S08

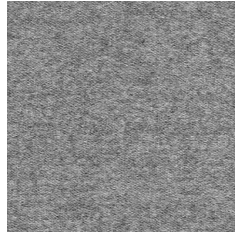

S16

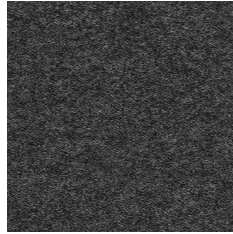

S17



S27



S45

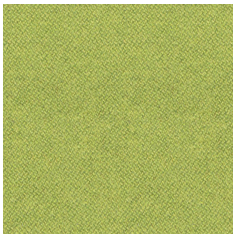

S46

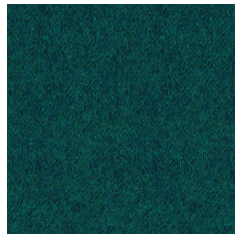

S50

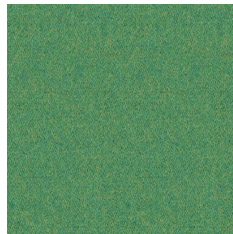

S53

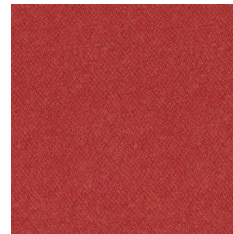

S55

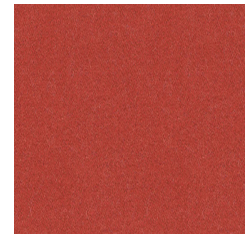

S56



S59

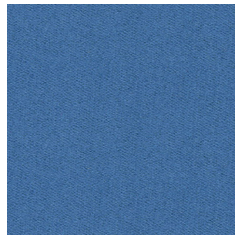

S62

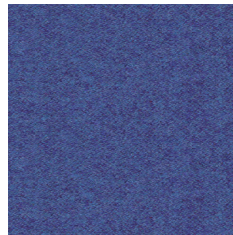

S63



S68

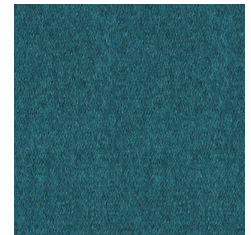

S69

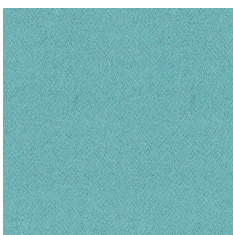

S84

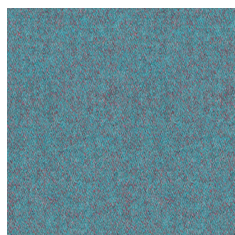

S85



Specials: Valchromat

Valchromat is a wood fibre panel coloured throughout, where fibres are coloured individually, impregnated with organic dyes and bonded together by a special resin which gives Valchromat unique physic and mechanical features. It is made with wood waste at a plant with zero carbon emission and have outstanding environmental credentials.

Valchromat is 30% stronger than regular MDF board providing for stronger furniture, where scratches and wear are less visible. It is non-toxic, emission free and is approved for contact with food.



Black SBL

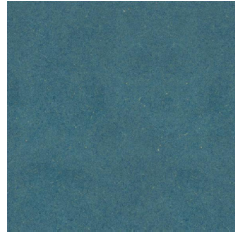

Blue SRB



Chocolate Brown SCB

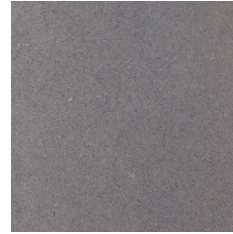

Grey SCZ



Green Mint SGM



Light Grey SLG



Orange SOR



Redv SSC



Violet SVI



Yellow SYW

The samples show untreated board. Applying surface treatment to Valchromat will result in darker, more saturated colours. All samples are meant to be indicative only as screens / print will vary.



Specials: Linoleum

Furniture Linoleum is a unique surfacing material for furniture applications such as desks, stools, cabinets, doors and displays. The material is naturally flexible and can be applied on all kinds of constructions.

This natural furniture surfacing material has a matt look and feels warm to the hand. It presents a number of new fresh and stylish colours that complement the classic greys and blacks.

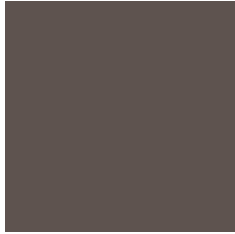

4172 Mauve



4154 Burgundy



4164 Salsa

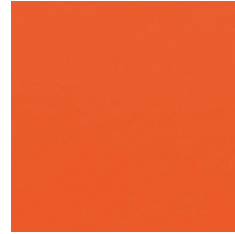

4186 Orange Blast



4185 Powder

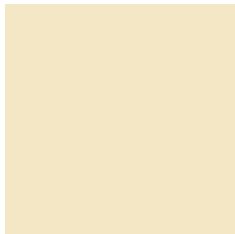

4157 Pearl

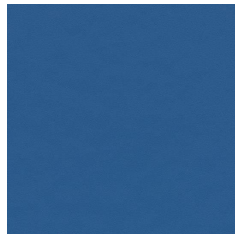

4181 Midnight Blue

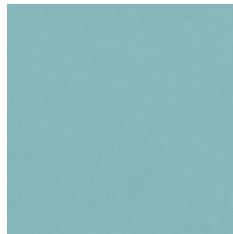

4180 Aquavert

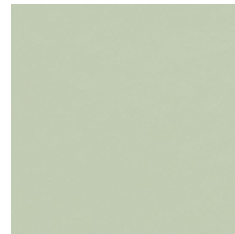

4183 Pistachio



4184 Olive



4174 Conifer



4182 Spring Green



4179 Smokey Blue



4023 Nero



4166 Charcoal

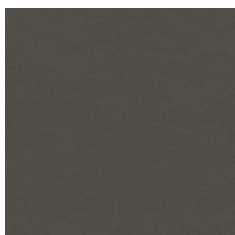

4178 Iron



4132 Ash



4177 Vapour



4155 Pewter

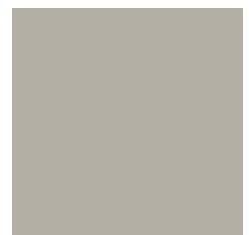

4175 Pebble

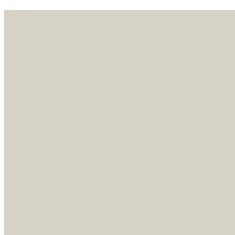

4176 Mushroom



Specials: Melamines & HPL

For project orders the whole range of melamines and high pressure laminates from Egger is available. Other manufacturers of laminates may be available on request.

Please note that minimum order quantities apply, depending on size and type of product. Leadtimes of specials can vary



Black
NCS S9000-N



Cosmos Grey
NCS S8500-N

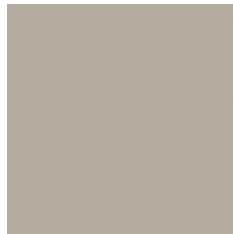

Pebble Grey
NCS S3005-Y20R



Alabaster White
NCS S0505-Y10R

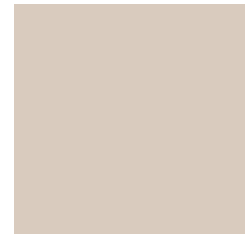

Cashmere Grey
NCS S2005-Y60R



Brown Grey
NCS S6005-Y20R

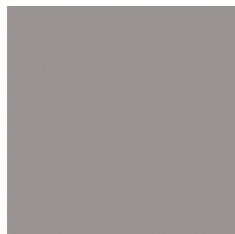

Arctic Grey
NCS S4500-N



Fjord Green
NCS S4010-B50G



Pistachio Green
NCS S2005-G20Y



Glacier Green
NCS S1020-B30G



Amazon Green
NCS S6030-B50G



Emerald Green
NCS S4050-B90G



Niagara Green
NCS S5030-B30G

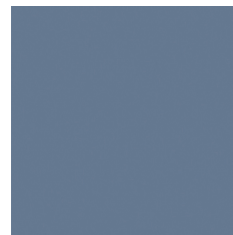

Smoke Blue
NCS S5020-R90B



Delft Blue
NCS S3060-R90B



Nude Brown
NCS S2020-Y40R



Olive Yellow
NCS S4030-Y

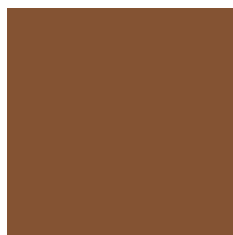

Nougat Brown
NCS S6020-Y50R

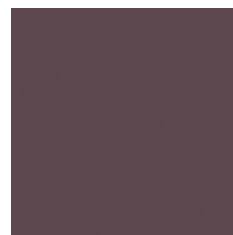

Aubergine Purple
NCS S7010-R30B



Midnight Blue
NCS S7020-R70B



Maize Yellow
NCS S1050-Y10R



Flamingo Pink
NCS S1040-R10B



Siena Orange
NCS S2570-Y40R



Indian Red
NCS S2075-Y70R



China Red
NCS S1580-Y90R



Project specials: Wood Veneers

For projects Elementa offers a wide array of different possibilities of wood veneer and surface treatments, for both cabinets and table-tops. It is also possible to match existing veneer samples. Minimum order quantities apply. Please inquire for pricing and availability.



Oak Natural



Whitened Oak



Ash



Pine



Birch



Beech

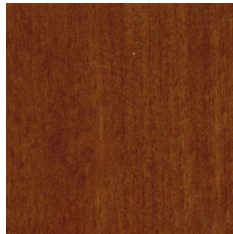

Beech Teak Stained



Walnut



Cherry

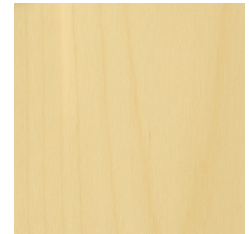

Maple



Oregon Pine

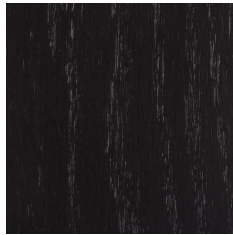

Black Painted Oak

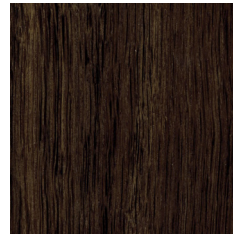

Smoked Oak

The pictured samples are meant to be indicative only, as rendition on screen and in print will vary from real product.



General Terms

Validity

The Terms of Sales and Delivery supersede and suspend all previous agreements and apply to any agreement made between ELEMENTA and the buyer unless otherwise agreed. ELEMENTA is entitled to modify these Terms at any time.

Sales and Marketing Material

Information supplied by ELEMENTA regarding prices, models, dimensions, features, and specifications in catalogues, advertisements, sales or promotional literature, price lists or elsewhere is not legally binding and shall be considered for guidance only, and may be changed at any time without prior notice. ELEMENTA reserves the right to make any changes to a product's design at any time.

Prices

The price list contains retail prices stated in NOK exclusive Norwegian VAT (MVA). The current price list replaces all previous price lists and may be subject to changes at any time without prior notice. The purchase price for ordered products is stated in the order confirmation. Delivery and installation is not included in the price. Unless otherwise agreed, quotations submitted by ELEMENTA are valid 30 days after receipt.

Orders

All orders must be in writing and shall at the minimum specify the type (product number and/or name) and quantity of the products ordered and the requested date of delivery. The order is not binding until ELEMENTA has issued an order confirmation. The order confirmation is considered accepted unless objections or changes are made within 3 working days. Cancellation of a confirmed order is subject to a cancellation fee set at 30% of the price stated in the order confirmation. Bespoke, unique or "one-off specials" cannot be cancelled.

Returns are only accepted on basis of written agreement. Unless otherwise agreed, the buyer shall also bear the transport cost and risk of any products returned to ELEMENTA in addition to any other costs agreed upon beforehand. Returned products shall be securely and properly packaged.

Payment

Unless otherwise agreed, payment shall be made in accordance with the payment terms and conditions of payment indicated on the invoice and the order confirmation.

All products remain the property of ELEMENTA until paid in full. The purchaser shall at all times keep unpaid products separated from any other products, and must ensure that the products can at all times be identified by ELEMENTA. Purchaser is liable to ELEMENTA for any damage to products until they have been paid for in full as stated above.

Payment made after due date will incur a penalty interest of 1.5% per month, payable without further notice.

Delivery

Unless otherwise agreed in writing, delivery shall be ex. works at ELEMENTA distribution in OSLO. Delivery date is an estimation and ELEMENTA cannot be held accountable for any deviations from dates or any damage or loss purchaser may suffer as a result of a delay or a non-delivery.



General Terms (cont.)

Warranty

ELEMENTA's warranty covers defects of manufacture and materials on standard products and is valid for 5 years. For outdoor products the warranty is valid for 2 years. For bespoke, unique or "one-off specials" the warranty is valid for 1 year. Excluded from this warranty are all defects due to or caused by transport, incorrect use, inadequate maintenance, accidents, the buyer's alteration or repair as well as normal wear and tear of the products. Natural variations in organic materials are not considered to be defects.

Claims

With respect to products that are defective, ELEMENTA may choose to refund the purchase price for such products, repair such products or replace such products, always provided that it is a condition for such refund, repair or replacement that the buyer has notified ELEMENTA about the defect within reasonable time after the buyer discovered or ought to have discovered it, and provided that such notice is given within the warranty period. Claims shall be filed electronically by submitting a detailed explanation and supporting photographic documentation to post@elementa.no

Complaints and Transport Damages

Purchaser is obligated to inspect deliveries upon receipt. The inspection shall include: a) Checking that the correct type of products have been delivered. b) Checking that the correct quantity of the products has been delivered. c) Ensuring that the products are of an acceptable quality. If the delivery is visibly damaged, the buyer shall: a) Inspect the entire delivery immediately. b) Accept the delivery, but immediately note the damage on the freight documents by stating "received with reservation". c) Report the extent of the damages to ELEMENTA. Claims pertaining to delivery or transport must be made within 3 working days upon receipt. Complaints shall be filed electronically by submitting a detailed explanation and supporting photographic documentation to post@elementa.no

Applicable Law & Venue

The Terms of Sale and Delivery shall be interpreted in accordance with applicable Norwegian law. Any dispute that may arise which cannot be settled amicably, shall be brought before the Oslo District Court.

Elementa Oslo

Kroloftet
Arnljot Gellines vei 41
0657 Oslo
Norway
www.elementa.no
post@elementa.no
Tlf +47 22468140